

July 2008

## Description

The TCS Temperature Concentrator System substantially reduces the cost of transmitting multiple temperature sensor measurements in general purpose and hazardous area\* applications by “concentrating” up to 32 signals onto one network.

The TCS quickly configures to accept any combination of RTD, T/C, mV and resistance/potentiometer signal inputs. It converts the inputs to the HART® digital communications protocol, and transmits the data long distances from the field to the control room, on an economical HART digital data link.

All process, status and diagnostic information can then be accessed by a HART-based DCS. When used with a Moore Industries HMC HART-to-MODBUS Converter, the TCM interfaces with a MODBUS RTU-based control system.



**The TCM Temperature Concentrator Module (left) and HMC HART-to-MODBUS Converter (right) feature rugged metal, RFI/EMI resistant housings that snap onto standard DIN-style rails.**

**Figure 1.** One or two\*\* 16-channel temperature concentrator modules (TCM) can be used on the same network to allow up to 32 signals to be economically transmitted back to the control room.

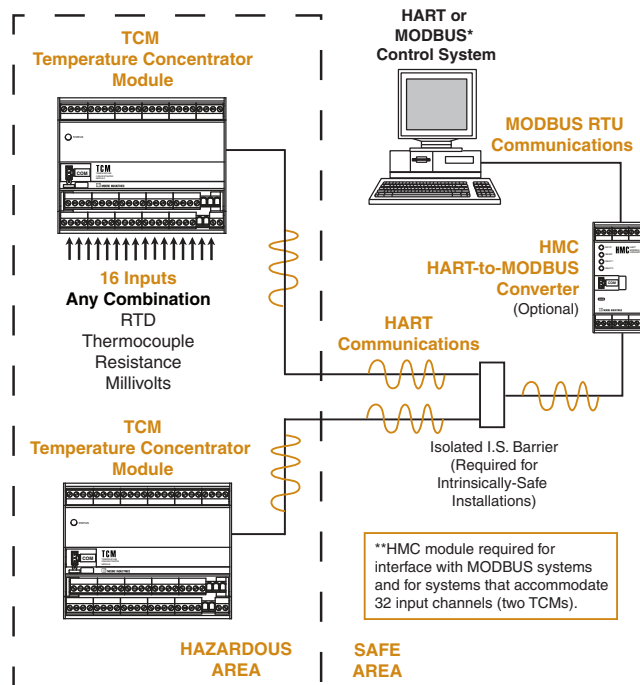

### Certifications

**CE** CE Conformant – EMC Directive 89/336/EEC EN 61326

\* **IMPORTANT:** Hazardous area approvals are in submittal. Consult the factory for details.

## Features

- **Substantially reduce hardware, wire, installation and I.S. barrier costs.** The TCS eliminates the need to install a dedicated transmitter and twisted wire pair (or expensive sensor extension wires) for each measurement. Only one I.S. barrier is needed to support up to 16 temperature points in intrinsically-safe applications.
- **Installs in hazardous areas\*.** Intrinsically-safe design allows the TCM Temperature Concentrator Module to be safely installed in any Class I, II, III, Division 1 (Zone 0/1) hazardous area.
- **Universal input options.** The TCS can be set to accept RTD (2-, 3-, 4-wire; Pt, Cu, Ni); thermocouple (J, K, E, T, R, S, N, B, C); resistance/potentiometer (0-4000 ohms); and millivolt (-50 to 1000mV) inputs.
- **HART and MODBUS RTU communications.** These standard communication protocols facilitate interface with a wide range of DCS, PLC and computer-based networks.
- **Programs using a HART Communicator, a HART-based system or FREE Windows® software.** Versatile programming options allow on-site or remote access to process information and the ability to perform parameter changes from the control room or any termination point on the twisted wire pair.

HART is a registered trademark of the HART Communication Foundation.

# TCS

## Temperature Concentrator System™ Multi-Channel Transmitter

### System Architecture

A TCS Temperature Concentrator System may consist of one or two (when used with an HMC HART-to-MODBUS Converter) 16-channel, loop-powered (2-wire) TCM Temperature Concentrator Modules; an optional 4-wire (line/mains-powered) HMC HART-to-MODBUS Converter; and, for intrinsically-safe applications\*, an optional I.S. barrier (P/N 9160/13-11-11s or 9160/23-11-11s or equivalent).

Each of the TCM Temperature Concentrator Module's 16 channels can be individually configured to accept an RTD, T/C, millivolt and/or resistance/potentiometer signal. When two TCM modules are used in a Temperature Concentrator System, up to 32 signals can be monitored over one twisted wire pair.

The TCM converts the signal inputs to the standard HART digital communications protocol and transmits the data long distances from the field to the control room on one economical digital data link.

The TCS is suitable for use in General Purpose and Non-Incendive Class I, Division 2 installations (Figures 2 and 4). For Intrinsically-safe Class I, II, III, Division 1 (Zone 0/1) hazardous areas, the TCM can be mounted in a hazardous area when an I.S. Barrier is installed on the data communications link.

**Figure 2.** TCS in general purpose or Class I, Division 2 or Zone 2 HART Communications Mode (accommodates one TCM per system).

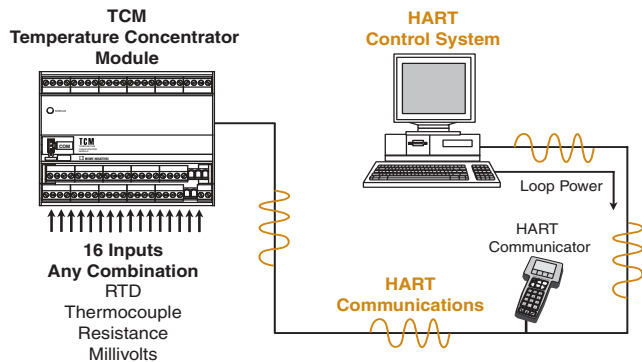

### HART Communications Mode

When used in the HART Communications Mode, one TCM Temperature Concentrator Module may be used within a system. The TCM communicates via the HART digital communications protocol, allowing direct interface with HART-based systems, such as an AMS. When communicating to a HART DCS, each of the TCM's 16 channels is assigned a unique HART address and set to act as a distinct HART slave device in a HART multi-drop network.

All TCM operating parameters (with the exception of custom input linearization) can be configured from the HART-based system, or using a standard HART hand-held, from anywhere along the twisted wire pair. The TCM can also be configured, including custom input linearization, using Moore Industries' FREE Intelligent PC Configuration Software.

**Figure 3.** TCS in Intrinsically-Safe\* HART Communications Mode (accommodates one TCM per system).

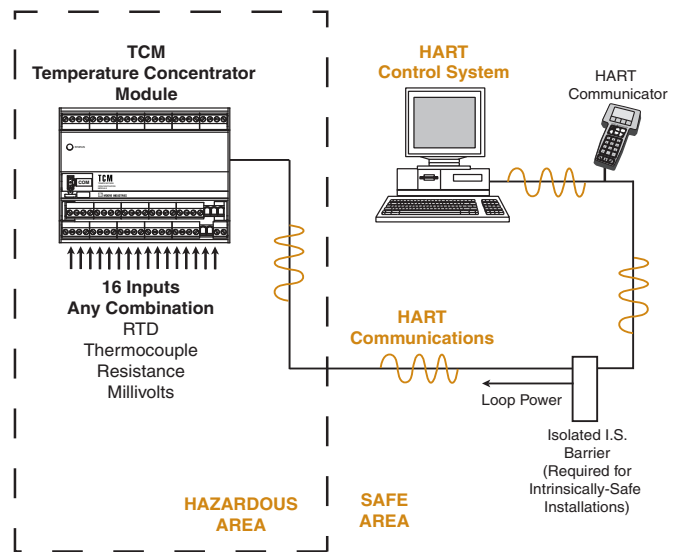

**\*IMPORTANT:** Hazardous area approvals are in submittal. Consult the factory for details.

### MODBUS RTU Communications Mode

If interfacing with a MODBUS RTU-based host system is required, the TCS is offered with the HMC HART-to-MODBUS Converter. When used with the HMC, two TCM Temperature Concentrator Modules can be used within a system, allowing up to 32 inputs to be monitored.

**HMC HART-to-MODBUS Converter**—Acting as the HART Primary Master, the HMC issues HART commands instructing the TCM to transmit all of its data in a single poll.

The HMC converts the TCM's HART digital data to a serial MODBUS RTU (RS-485) communications protocol to allow direct connection with MODBUS-based monitoring and control systems (such as a PLC or DCS). The HMC offers dual MODBUS communication ports so redundant communications can take place with one or more MODBUS RTU hosts.

If the HMC is specified for the application, the TCM can still be configured from any termination point along the twisted wire pair, beyond the input side of the HMC, using a HART hand-held.

The HMC is configured using Moore Industries' FREE HMC Intelligent PC Configuration Software.

**HMC Powers Two TCM Modules**—When installed on the communications link, the HMC can supply loop power (transmitter excitation) to one or both TCM Temperature Concentrator Modules. This eliminates the need to install an additional external supply to power the TCM modules.

**HMC Fault Alarms**—The HMC can be programmed via the PC software to provide two relay outputs (one for each TCM) rated 2A@250Vac (non-inductive loads, 50/60Hz). The relays can be set to send a master alarm when the HMC detects one, any, or all of the following fault conditions within the system: No HART signal; broken wire; hardware error; bad configuration; input saturated; and input out of table range.

The alarms can be set with a time delay, which specifies how long (in seconds) the alarm condition needs to exist before the alarm trips. Failsafe and Non-Failsafe alarm action is also configurable.

**Figure 5.** TCS in Intrinsically-Safe\* MODBUS RTU Communications Mode.

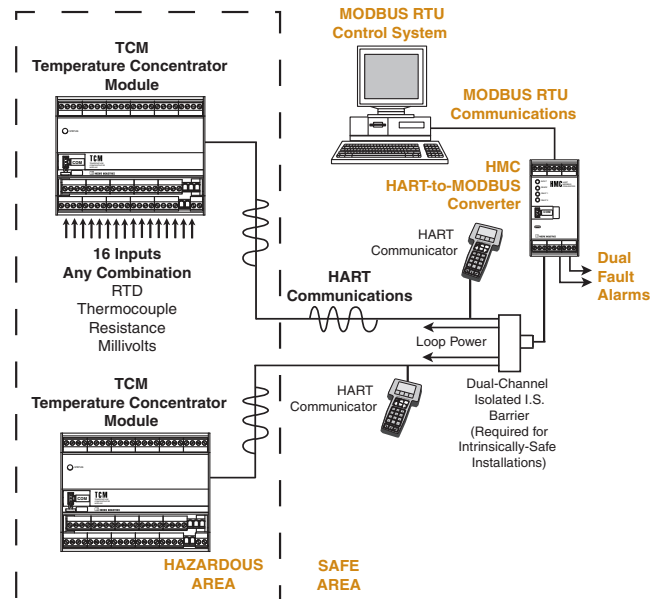

**\*IMPORTANT:** Hazardous area approvals are in submittal. Consult the factory for details.

**Figure 4.** TCS in MODBUS RTU Communications Mode.

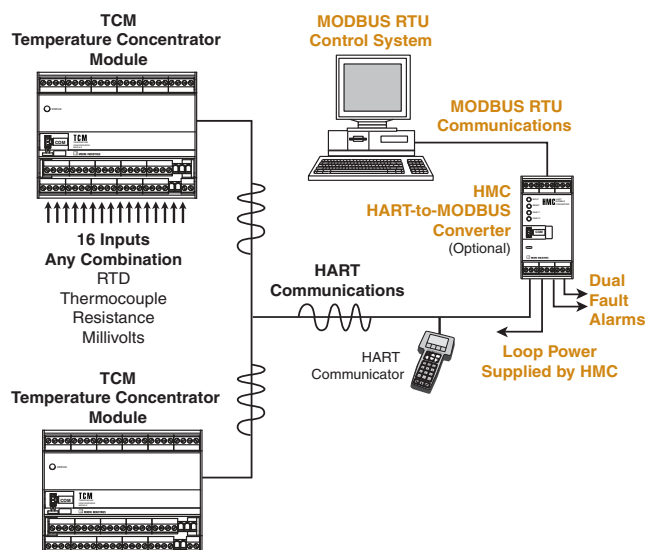

# TCS

## Temperature Concentrator System™ Multi-Channel Transmitter

### Ordering Information

#### TCM Temperature Concentrator Module

Unit	Input	Output	Power	Options	Housing
<b>TCM</b> Temperature Concentrator Module	<b>TPRG</b> 16 input channels program to accept:  RTD (2-, 3-, 4-wire; platinum, copper and nickel)  Thermocouple: (J, K, E, T, R, S, N, C, B)  Resistance: 0-4000 ohms  Millivolts: -50 to +1000mV  (see Table 4 for additional information)	<b>HART</b> Hart Digital Communications Protocol	<b>15-42DC</b> for non-Intrinsically-Safe installations  <b>15-30DC</b> for Intrinsically-Safe and Non-Incendive applications	None	<b>DIN</b> Universal DIN-style housing mounts on 32mm (EN50035) G-type and 35mm (EN50022) Top Hat DIN-rails

**To order, specify:** Unit / Input / Output / Power / Options [Housing]

**Model Number Example:** TCM / TPRG / HART / 15-42DC / [DIN]

#### HMC HART-to-MODBUS Converter

Unit	Input	Output	Power	Options	Housing
<b>HMC</b> HART-to-MODBUS Converter	<b>HART</b> Accepts a HART communications protocol input from the TCM Temperature Concentrator Module	<b>MB</b> MODBUS RTU (RS-485) Communications	<b>24DC</b> (20-30Vdc)	<b>None</b>	<b>DIN</b> Universal DIN-style housing mounts on 32mm (EN50035) G-type and 35mm (EN50022) Top Hat DIN-rails

**To order, specify:** Unit / Input / Output / Power / Options [Housing]

**Model Number Example:** HMC / HART / MB / 24DC [DIN]

### I.S. Barrier

To use the TCS Temperature Concentrator System in an intrinsically-safe\* Class I, II, III, Division 1 (Zone 0) hazardous area, specify an I.S. Barrier listed below or equivalent.

**P/N 9160/13-11-11s**—Single-Channel Isolated I.S. Barrier (STAHL Type 9160/13-11-11s; Consult the STAHL data sheet for details and specifications)

**P/N 9160/23-11-11s**—Dual-Channel Isolated I.S. Barrier (STAHL Type 9160/23-11-11s; Consult the STAHL data sheet for details and specifications)

\* **IMPORTANT:** Hazardous area approvals are in submittal. Consult the factory for details. It is the responsibility of the installer to select and install per the manufacturer's guidelines an agency approved I.S. Barrier appropriate for the specific application.

### FREE Software and Cable

Each TCM and HMC order comes with one copy of our Intelligent PC Configuration Software (Windows® compatible) and a configuration cable. Use the following information to order additional parts:

**P/N 750-75E05-01**—Interface Solution PC Configuration Software on CD (One copy comes free with each order)

**P/N 803-040-26**—Non-Isolated PC Configuration Cable (one comes free with each order)

**P/N 803-039-26**—Isolated PC Configuration Cable

**P/N 235-829-02**—PC-Programming Kit includes one copy of our Intelligent PC Configuration Software and one HART-to-RS232 Cable with HART modem

**P/N 803-048-26**—HART-to-RS232 Smart Interface Cable with HART Modem

### Specifications (TCM Temperature Concentrator Module)

**HART Address Range:** 0-15 (in HART Communications Mode)  
**Transmission Speed:** 1200bps  
**Character Format:** 1 Start Bit - 8 Data Bits - 1 Odd Parity Bit - 1 Stop Bit

**Performance Input Accuracy:** Refer to Table 4  
**Overall Accuracy:** The overall accuracy of the unit is the input accuracy. It includes the combined effects of linearity, hysteresis, repeatability and adjustment resolution. It does not include ambient temperature effect. For T/C input, add the Reference Junction Compensation error  
**Reference (Cold) Junction Compensation:** ±0.65°C (±1.17°F)  
**Stability:** Refer to Table 1  
**Isolation:** 500Vrms between inputs and output (no isolation between individual input channels)  
**Input Overload Protection:** ±5Vdc, maximum

**Performance Digital Input Filter:** 50/60 Hz, User-configurable  
**Power Supply Requirements:** 15-42Vdc, 15mA maximum, 12.5mA typical  
**Input Impedance:** T/C and mV: 40Mohms, nominal  
**RTD and Ohms Excitation:** 210microamps, ±10%  
**RTD Lead Wire Resistance Maximum:** RTD resistance + 2X lead wire resistance: < 4000 ohms max; Recommended lead wire resistance for 3-wire connections: <35 ohms/wire; 10 ohm copper sensor <5 ohms

**Indicators LED Type:** STATUS LED: Red indicates Power On, Not-Initialized; Green indicates Power On, System OK; Green/Amber (flashing): Power On, Communication detected Red/Green (flashing): Power On, Error

**Ambient Temperature Operating and Storage Range:** -40°C to +85°C (-40°F to +185°F)  
**Relative Humidity:** 0-95%, non-condensing  
**Ambient Temperature Effect:** Refer to Table 3  
**Startup Time:** <0.5sec, maximum  
**Loss of Input:** HART status byte indicates faults  
**Noise Rejection:** Common mode, 100dB@50/60Hz; Normal Mode: Refer to Table 2  
**RFI/EMI Immunity:** 10V/m@80-1000MHz, 1kHz AM, when tested according to IEC61326

**Weight** 749g (1.7 lbs)

#### I.S. Entity Parameters (Power/Loop, +PS & -PS):

Vmax or Ui = 30Vdc  
 Imax or li = 110mA  
 Pmax or Pi = 0.825W  
 Ci = 0F  
 Li = 0H  
 Lo/Ro = 43.1µH/ohms

#### Sensor

Ca = 12.4µF  
 La = 422.7µH  
 Voc = 4.0Vdc  
 Isc = 290mA

Table 1. Long-Term Stability

Stability (% of maximum span)	Input-to-HART (Years)		
	1	3	5
RTD, Ohm & Pot Inputs	0.047	0.081	0.104
T/C & mV Inputs	0.08	0.14	0.18

Table 2. Normal Mode Rejection Ratio Table

Sensor Type	Max. p-p Voltage Injection for 60dB at 50/60Hz	
T/C: J, K, N, C, E	125mV	
T/C: T, R, S, B	80mV	
Pt RTD: 100, 200, 300 ohms	250mV	
Pt RTD: 400, 500, 1000 ohms	500mV	
Ni: 120 ohms	500mV	
Resistance		
1-4kohms	mV	500mV
0.25-1kohms	250-1000	200mV
0.125-0.25kohms	62.5-250	100mV

Table 3. Ambient Temperature Effect

Input Type	Accuracy per 1°C (1.8°F) change in Ambient
*RTD	0.0035°C
Millivolt	0.5 microvolts + 0.005% of reading
Ohm	0.002 ohms + 0.005% of reading
Thermocouples	
Input Type	Accuracy per 1°C (1.8°F) change in Ambient
J	0.00016°C + 0.005% of reading
K	0.0002°C + 0.005% of reading
E	0.00026°C + 0.005% of reading
T	0.0001°C + 0.005% of reading
R, S	0.00075°C + 0.005% of reading
B	0.0038°C + 0.005% of reading
N	0.0003°C + 0.005% of reading
C	0.00043°C + 0.005% of reading

\*Accuracy of Ni672 is 0.002°C

# TCS

## Temperature Concentrator System™ Multi-Channel Transmitter

**Table 4.** TCM Accuracy with RTD, Thermocouple, Ohms, and Millivolt Inputs

Input	Type	$\alpha$	Ohms	Conformance Range	Minimum Span	Input Accuracy	Maximum Range
RTD	Platinum	0.003850	100	-200 to 850°C -328 to 1562°F	10°C (18°F)	±0.1°C (±0.18°F)	-240 to 960°C -400 to 1760°F
			200				
			300				
			400				
			500				
		1000					
		0.003902	100	-100 to 650°C -148 to 1202°F			-150 to 720°C -238 to 1328°F
			200				
			400				
			500				
1000							
0.003916	100	-200 to 510°C -328 to 950°F	-240 to 580°C -400 to 1076°F				
Nickel	0.00672	120	-80 to 320°C -112 to 608°F	-100 to 360°C -148 to 680°F			
Copper	0.00427	9.035	-50 to 250°C -58 to 482°F	±0.85°C (±1.53°F)	-65 to 280°C -85 to 536°F		
Ohms	Direct Resistance	n/a	0-4000 ohms	0-4000 ohms	10 ohms	±0.4 ohms	0-4095 ohms
	Potentiometer		125, 250, 500, 1k, 2k, 4kohms	0-100%	10%	±0.1%	0-100%
T/C	J	n/a	n/a	-180 to 760°C -292 to 1400°F	35°C 63°F	±0.25°C (±0.45°F)	-210 to 770°C -346 to 1418°F
	K	n/a	n/a	-150 to 1370°C -238 to 2498°F	40°C 72°F	±0.3°C (±0.54°F)	-270 to 1390°C -454 to 2534°F
	E	n/a	n/a	-170 to 1000°C -274 to 1832°F	35°C 63°F	±0.2°C (±0.36°F)	-270 to 1013°C -454 to 1855.4°F
	T	n/a	n/a	-170 to 400°C -274 to 752°F	35°C 63°F	±0.25°C (±0.45°F)	-270 to 407°C -454 to 764.6°F
	R	n/a	n/a	0 to 1760°C 32 to 3200°F	50°C 90°F	±0.55°C (±0.99°F)	-50 to 1786°C -58 to 3246.8°F
	S	n/a	n/a	0 to 1760°C 32 to 3200°F	50°C 90°F	±0.55°C (±0.99°F)	-50 to 1786°C -58 to 3246.8°F
	B	n/a	n/a	400 to 1820°C 752 to 3308°F	75°C 135°F	±0.75°C (±1.35°F)	200 to 1836°C 392 to 3336.8°F
	N	n/a	n/a	-130 to 1300°C -202 to 2372°F	45°C 81°F	±0.4°C (±0.72°F)	-270 to 1316°C -454 to 2400.8°F
	C	n/a	n/a	0 to 2300°C 32 to 4172°F	100°C 180°F	±0.8°C (±1.44°F)	0 to 2338°C 32 to 4240.4°F
Millivolts	DC	n/a	n/a	-50 to 1000mV	4mV	15 microvolts	-50 to 1000mV

## Specifications (HMC HART-to-MODBUS Converter)

<p><b>Performance</b> <b>Input Accuracy:</b> Reflects the accuracy of the TCM  <b>Input Impedance:</b> Transmit Mode: 150 ohms; Receive Mode: Greater than 5kohms  <b>Maximum Input Over-Range:</b> ±5Vdc  <b>Isolation:</b> 1000Vrms between case, input, MODBUS outputs and power terminals, continuous, and will withstand 1500Vac dielectric strength test for one minute (with no breakdown)  <b>Power Supply:</b> 24Vdc, nominal; 20-30Vdc limits  <b>Power Consumption:</b> 4-7W, nominal; 9W@24Vdc, maximum for units using TX  <b>+TX Power Supply:</b> 25.8Vdc ±3%@40mA  <b>Digital Response Time:</b> 1 second from TCM input to MODBUS output; MODBUS response time depends on how fast and how often a MODBUS Master requests data from the HMC; the data response time from request is 50msec</p>	<p><b>Performance (Continued)</b> <b>Alarm Response Time:</b> Digital Response Time + 150msec, maximum (defined as the time from when the field instrument reports a fault until the HMC alarm is tripped)  <b>Alarm Trip Delay:</b> Programmable from 0-120sec  <b>Output Type:</b> Standard MODBUS RTU protocol interface over RS-485 (parameters as specified in U.S. Standard EIA-RS485)  <b>Address Range:</b> Configurable from 1 to 247. Unit will assume a MODBUS address of 1 by default  <b>Baud Rate:</b> Interface supports the following: 300, 600, 1200, 2400, 4800, 9600 and 19.2k. Unit will assume a baud rate of 9600 and no parity by default  <b>Parity:</b> MODBUS interface will support even, odd or no parity  <b>Character Format:</b> One start bit, 8 data bits and one stop bit  <b>Data Format:</b> User-selectable; Standard LSW (Least Significant Word) first or Swapped MSW (Most Significant Word) first. Unit will assume Standard LSW by default</p>	<p><b>Indicators</b> <b>LED Type:</b> Dual color red/green indicate:  INPUT LED: Input is present and normal (green); input signal is not found (red)  READY LED: Instrument is ready for operation and configuration (green); instrument has encountered an internal problem (red)  FAULT 1: Shows status of TCM 1. No alarm condition (green); Instrument is in an alarm state (red)  FAULT 2: Shows status of TCM 2. No alarm condition (green); Instrument is in an alarm state (red)</p> <p><b>Ambient Conditions</b> <b>Operating and Storage Range:</b> -40°C to +85°C (-40°F to +185°F)  <b>Relative Humidity:</b> 0-95%, non-condensing  <b>RFI/EMI Immunity:</b> 20V/m@80-1000MHz, 1kHz AM, when tested according to IEC61326  <b>Noise Rejection:</b> Common Mode: 100dB@50/60Hz</p> <p><b>Weight</b> 454g (1.0 lb)</p>
---	--	--

# TCS

## Temperature Concentrator System™ Multi-Channel Transmitter

Figure 6. TCM Temperature Concentrator Module Dimensions

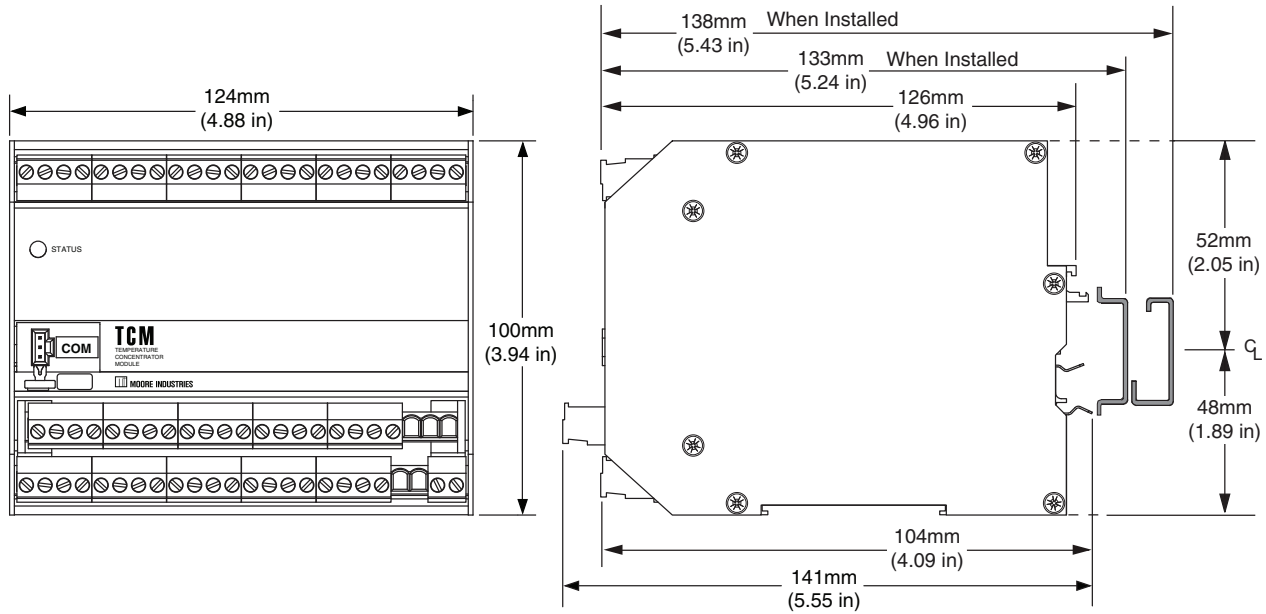
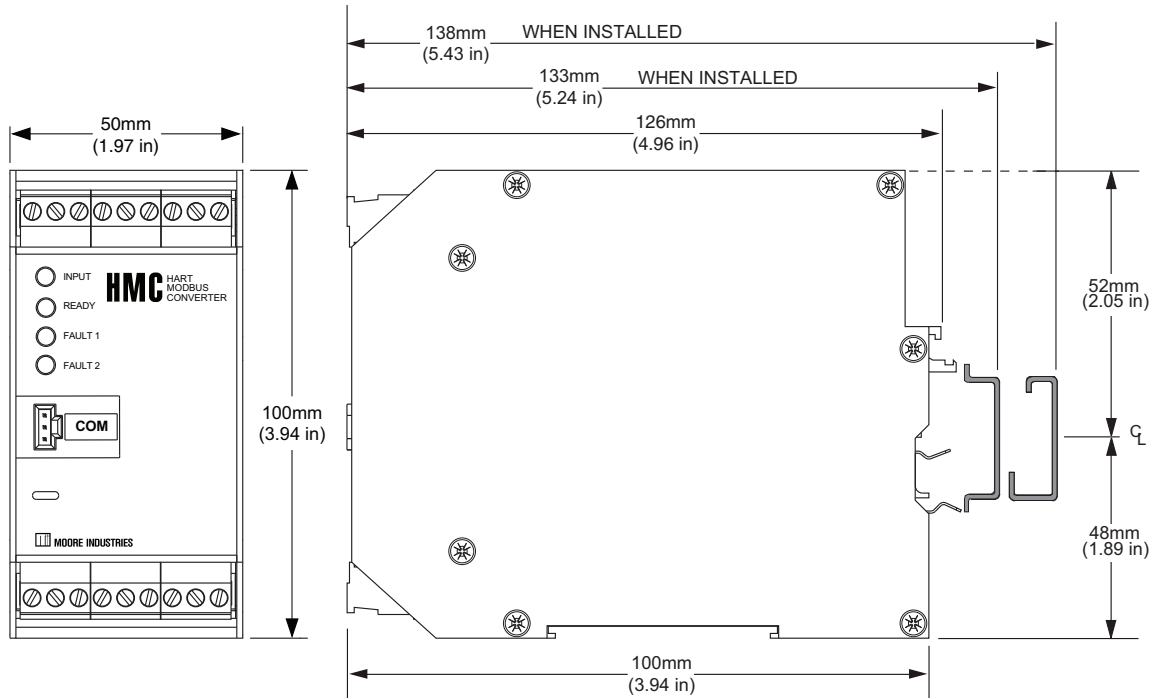

Figure 7. HMC HART-to-MODBUS Converter Dimensions



WORLDWIDE • [www.miinet.com](http://www.miinet.com)

United States • [info@miinet.com](mailto:info@miinet.com)  
Tel: (818) 894-7111 • FAX: (818) 891-2816  
Australia • [sales@mooreind.com.au](mailto:sales@mooreind.com.au)  
Tel: (02) 8536-7200 • FAX: (02) 9525-7296

Belgium • [info@mooreind.be](mailto:info@mooreind.be)  
Tel: 03/448.10.18 • FAX: 03/440.17.97  
The Netherlands • [sales@mooreind.nl](mailto:sales@mooreind.nl)  
Tel: (0)344-617971 • FAX: (0)344-615920

China • [sales@mooreind.sh.cn](mailto:sales@mooreind.sh.cn)  
Tel: 86-21-62491499 • FAX: 86-21-62490635  
United Kingdom • [sales@mooreind.com](mailto:sales@mooreind.com)  
Tel: 01293 514488 • FAX: 01293 536852